

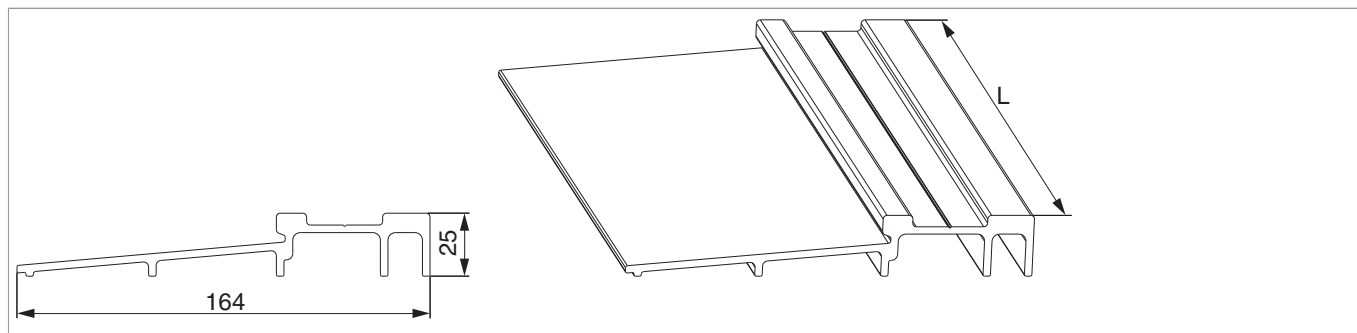



462533 - Soglia HS in vetroresina S=164 mm H=25 mm L=2.500mm argento

Disegni tecnici



			L		No
Soglia HS in vetroresina	argento	S=164 mm H=25 mm	2.500	1	462533