

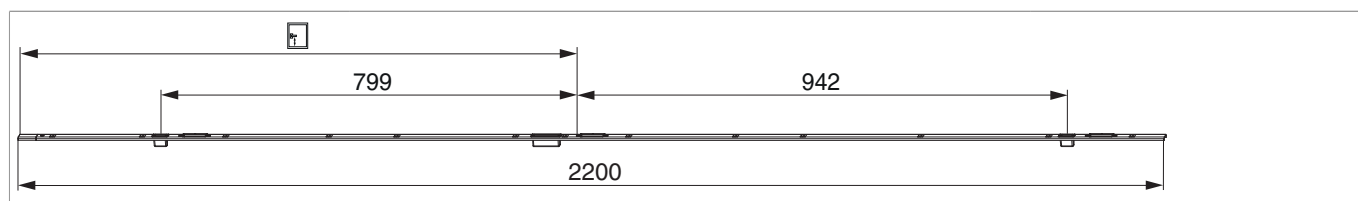





215909 - Asta scontri 2 scrocchi-punzoni K+980 destro PB 24 mm scost. 13 mm U-6/24/6 argento

Disegni tecnici



					B		L			Nº
argento	destro	Asta scontri PB 24 mm scost. 13 mm	2 scrocchi-punzoni K+980	6	24	6	2.200	13	5	215909 ^{1) 2)}

¹⁾ Utilizzabile con copri vite 362704

²⁾ Viene utilizzato con serratura automatica comando cilindro Z-TF



Posizionamento dell'asta scontri

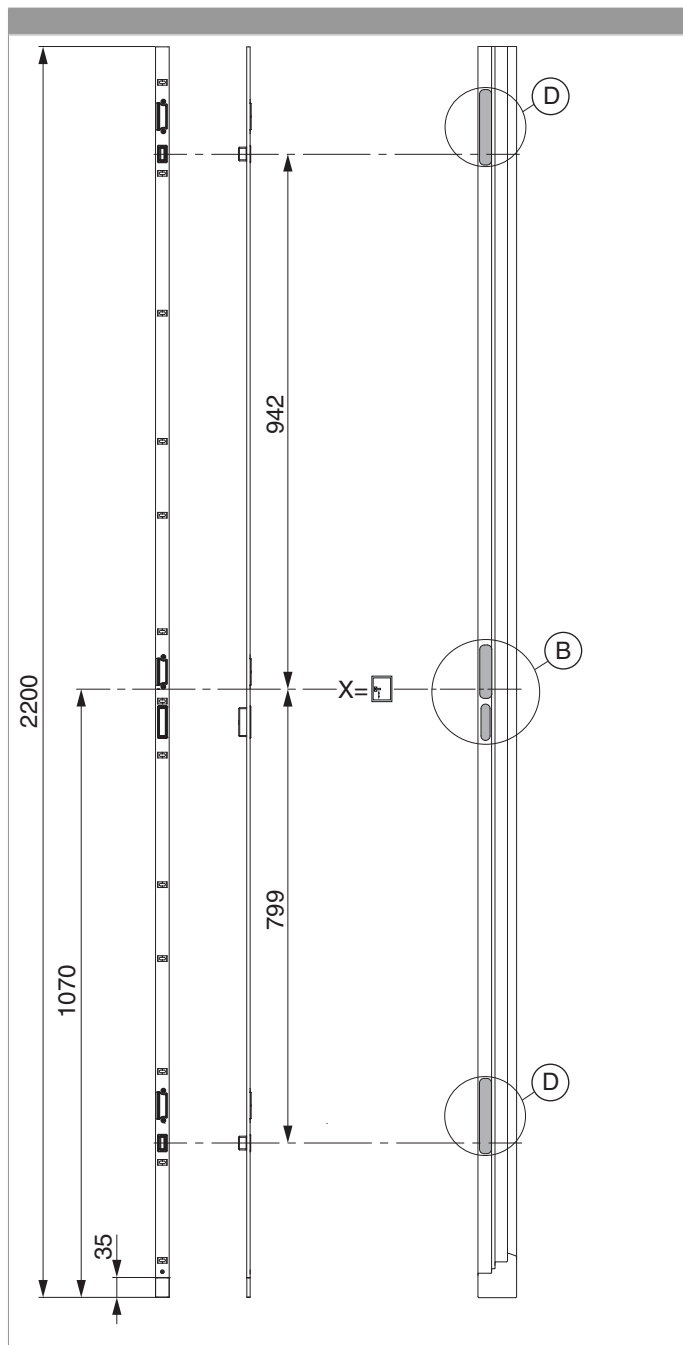



Schema foro e fresata

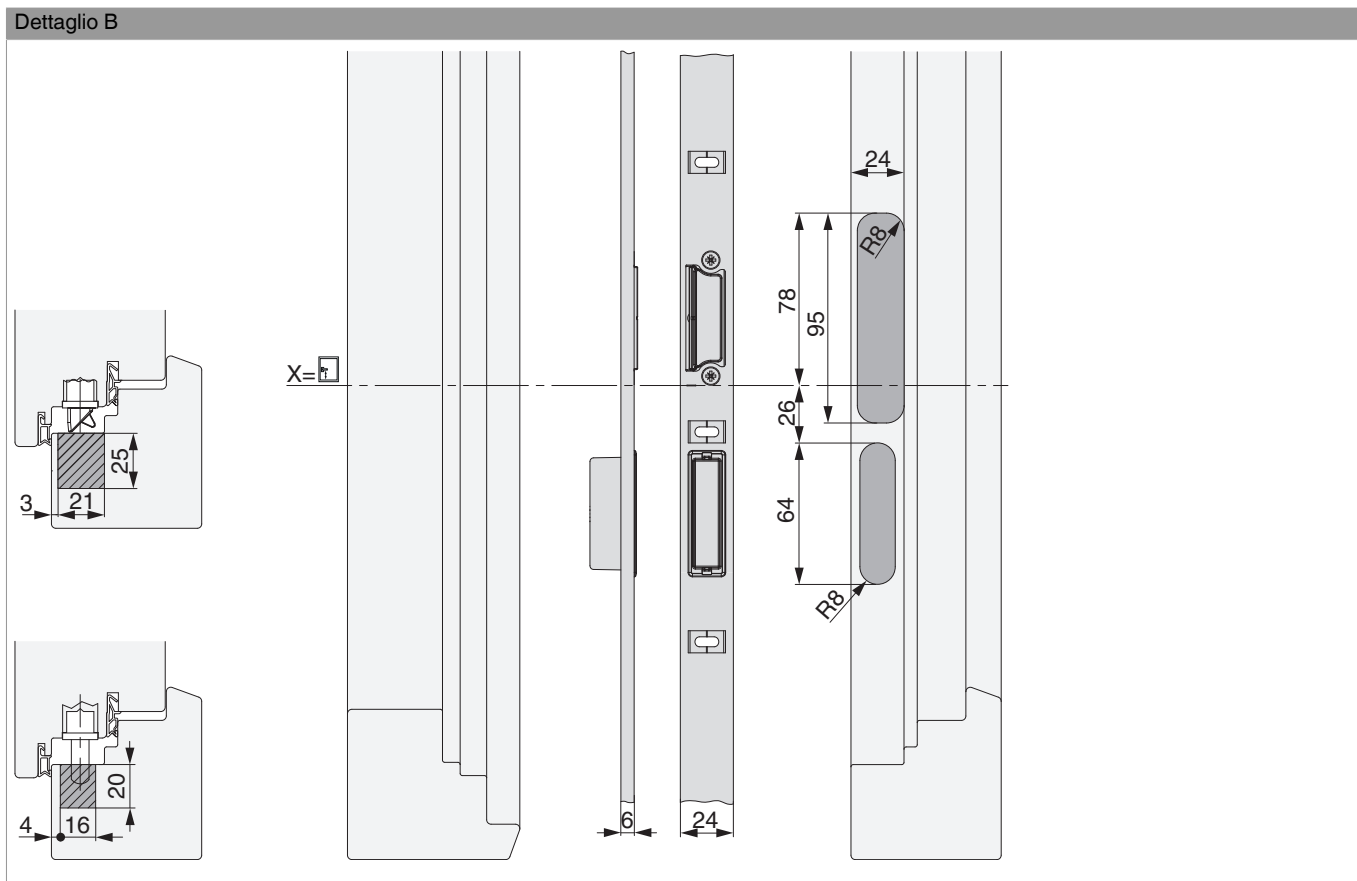



Dettaglio D

